

Solar Photovoltaic Fed Induction Motor For Water Pumping System Using MPPT Algorithm

1JIRALA BHARGAVKUMAR BALKRUSHNA, 2Yogi RonakKumar Shaileshbhai, 3Bava Dipakpuri Cheharpuri, 4Shrimali Vaibhavgkumar Revachandbhai, 5Parmar Shreyashkumar Kantilal
 Student
 Hansaba Collage of Engineering and Technology

Abstract - The work focuses on the photovoltaic array fed water pumping system utilizing induction Motor with the Model developed in PSIM . The solar panels to absorb and convert sunlight into electricity . Maximum Power Point Tracking (MPPT) is a technique used to maximize output Power from the PV and finally a 3- phase induction Motor is driven by it . The photovoltaic array is used to run an induction Motor that drives the centrifugal pump . The PV array connected to induction Motor where MPPT technique (p & o) and (Inc .) plays an important role that is developed in PSIM and the o utputs are observed . The PV system cost for Maximizing the output of a PV system , continuously tracking the maximum M power point (MPP) is necessary .

keywords - Maximum Power Point Tracking (MPPT) , MPPT Efficiency , Boost Converter Photovoltaic Array . Perturb and Observe (P & O) . Incremental Conductance (INC) , Induction Motor , Centrifugal Water Pump

I. INTRODUCTION

The non-renewable sources are rapidly decreasing and the demand is increasing continuously, solar photovoltaic energy is one of the solutions for this problem. The solar photovoltaic energy which is free and abundant is highly beneficial and economical to many industrial applications. Solar photovoltaic fed water pumping system is one of the most popular applications of solar energy [5].

The P-V or I-V characteristics which give high efficiency and produces high output power curve that is known as Maximum Power Point[4]. It continuously varies with the atmospheric condition like radiation and temperature.A maximum power point tracking (MPPT) is drawn maximum power from the changing the weather condition a solar array. Nowadays the number of MPPT techniques have been developed for the tracking the maximum power point (MPPT). Then, Two drawbacks are considered like generating power from PV systems has the efficiency is very low underbecause low radiation condition and the second the electric power generated by solar arrays is always changing with changing weather conditions i.e., irradiation and temperature [3]. The number of maximum power point tracking (MPPT) algorithms are used for maximizing the output of the PV system. There are some methods are hill climbing method, perturbation, and observation method (P&O), Incremental conductance method (INC), constant voltage method(CV), constant current method (CI), modified hill climbing method[6]. The most commonly used methods to track MPP are the INC algorithm and P&O algorithms by adjusting the dutycycle of Boost converter.

II. PHOTOVOLTAIC CELL

The PV array produces the electrical energy from the solar energy directly and its output is changed by changing the atmospheric condition i.e. temperature and irradiance. As pumping system is the most promising applications of photovoltaic cells. Photovoltaic cells, or solar cells as they are more commonly referred to, are available commercially in a number of different semiconductor materials. The most common materials are monocrystalline silicon, polycrystalline silicon, amorphous silicon and copper-indium selenite (CIS). Figure 1 shows a PV system where the PV array feeds to the DC-DC converter (boost converter). The output of the converter is giving a constant DC voltage [7].

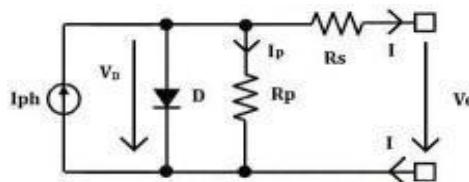

Figure 1: Equivalent Circuit of a PV Cell[4]

Derived from the Kirchoff's first law (also referred to as Kirchhoff's current law), the output current is given by

$$I = I_{ph} - I_d - I_p$$

$$I = I_{ph} - I_{sat} \left(\exp \frac{q \cdot (V_o + I \cdot R_s)}{n \cdot K \cdot T_{cell} \cdot N_s} - 1 \right) - \frac{V_o + I \cdot R_s}{R_p}$$

$$= h - 1 - \frac{(V_0 + I.RS)}{T_{total} \Delta t}$$

Where,

I - Output current

I_{ph}- Photo current

I_{sat}- Diode reverse saturation voltage

V_o - Output Voltage

R_s - Series resistance (Representing voltage loss on the way to external connectors)

R_p- Parallel resistance (Representing leakage currents)

k- Boltzmann’s constant

q - Charge on electron

N_s - Number of cells in series

N - Ideality factor

T_{cell} -Solar panel temperature

The I-V characteristics of a typical solar cell are as shown in the Figure 2

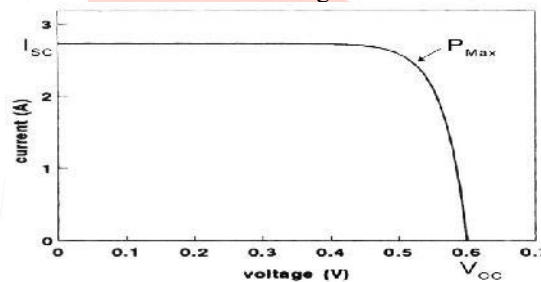

Figure 2: I-V Characteristics of a Solar Panel [4]

III. P-V & I-V CHARACTERISTICS FOR DIFFERENT TEMPERATURE AND RADIATION CONDITION

[A].Irradiance Change

The changing of irradiance which effects on an I-V curve as shown in Figure 3. If the irradiation is increased then the MPP is shifted in the vertical direction of the I-V curve as shown in Figure 3. This change can be shifting of the maximum operating current at MPP and the short-circuited current values in the vertical direction by increasing the radiation. Figure 3 shows the output characteristics of the PV panel at constant temperature and varying irradiance. These curves are nonlinear and they are affected by solar radiation [3].

[B].Temperature Change

The change in temperature of the PV array is a slowly changing process in domestic type application. The temperature change is the effect on the I-V curve as shown in Figure 4. In the result, the MPP is shifting the horizontal direction of I-V curve. In Figure 4 show the output characteristics of the PV panel as functions constant irradiation and varying temperature. These curves are nonlinear and they are affected by solar temperature [3].

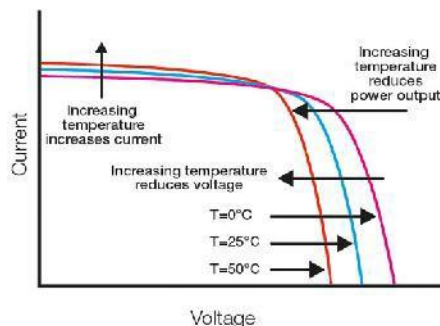

Figure 3: Effect on I-V Characteristics Due to Change of Temperature [3]

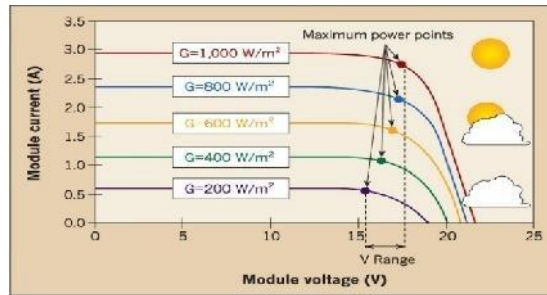

Figure 4: Effect on I-V Char. Change of Radiation [3]

IV. MAXIMUM POWER POINT TRACKING ALGORITHM

A typical solar panel converts only 30 to 40 percent of the incident solar irradiation into electrical energy. Maximum power point tracking technique is used to improve the efficiency of the solar panel [4].

There is the single point on I-V or P-V characteristic curve known as Maximum Power Point where PV system gives the highest efficiency and produces highest output power. The main source of the power loss is the failure to track MPP. So,

Maximum Power Point Tracking is essential to operate PV system at MPP. The most commonly used methods to track MPP are the INC algorithm and P&O algorithms by adjusting the duty cycle of DC to DC converter. Performance of a photovoltaic-based system strongly depends upon the capability to determine an optimal operating point of the solar array at which the maximum power can be drawn for any given load. Under certain temperature and light intensity, there is an only single maximum-power point in a normal cell. Therefore, maximum power point tracking (MPPT) of the solar cell is essential as far as the system efficiency is concerned [4].

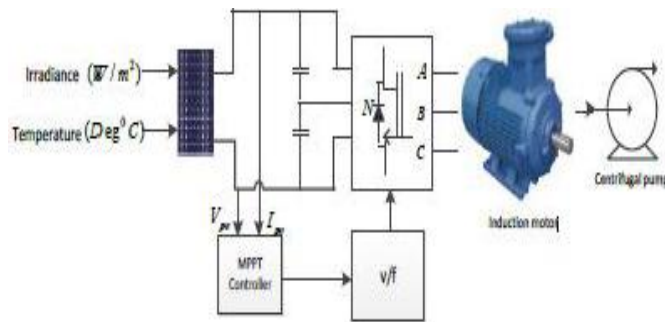

Figure 5: Project Block Diagram [5]

[2]: There are different techniques used to track the maximum power point. Few of the most popular techniques are

- Perturb and observe (hill climbing method)
- Incremental Conductance method (Inc.)
- Fractional short circuit current
- Fractional open circuit voltage
- Neural networks
- Fuzzy logic

[A] MPPT Using P&O Algorithm

In the P&O algorithm continuously taking increments or decrements the reference voltage depending on the value of the previously taking power sample. The P&O algorithm is the simplest method and cost of implementation is less and so it is easy to implement. The disadvantages are that the operating point is oscillating around the MPP [3].

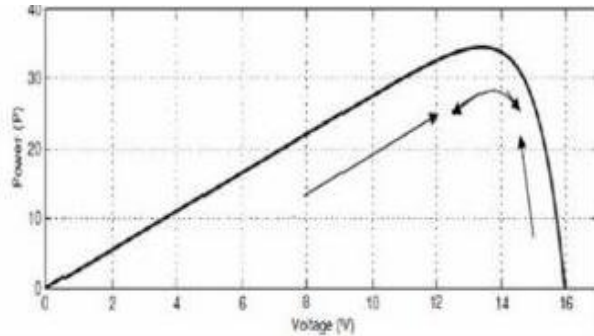

Figure 6: Perturb and Observe Algorithm [3]

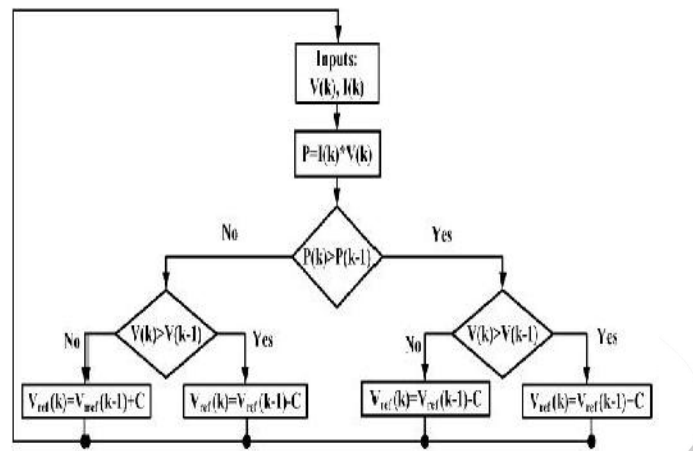

Figure 7: The Flowchart of the P&O Algorithm

The algorithm determines the reference voltage $V_{ref}(k)$ for the PV array voltage controller. The power at the current instant $P(k)$ is calculated from the instantaneous voltage and current $V(k)$ and $I(k)$ respectively. Next $P(k)$ is compared with the power of the previous instance $P(k-1)$. If the power has increased, then the algorithm checks the last change in the PV array voltage and continues to change it in the same direction, either by adding or subtracting the incremental value C to the reference voltage. However, if the power has decreased, the change of the voltage is set in the opposite direction.

This process is repeated till the system reaches MPP and then it oscillates near the MPP. The magnitude of oscillation depends on the magnitude of the perturbation and the frequency of update. The algorithm can be optimized to reduce the oscillation. One drawback of this method is that it fails under rapidly changing irradiance and environmental conditions. This occurs when the change in power due to atmospheric conditions is larger and in the opposite direction than the changes due to perturbation caused by the algorithm, which results in the operating point shifting in the opposite direction.

Advantages

- Accurate result
- Reliable and efficient technique
- Independent of the panel properties and characteristics

Disadvantages

- Accuracy and required time are dependent on size of the perturbation.
- Not suitable for fast -changing environmental conditions.
- Output voltage and current signals of PV panel oscillate.
- Even at a steady state

V. SIMULATION OF MPPT USING P&O ALGORITHM

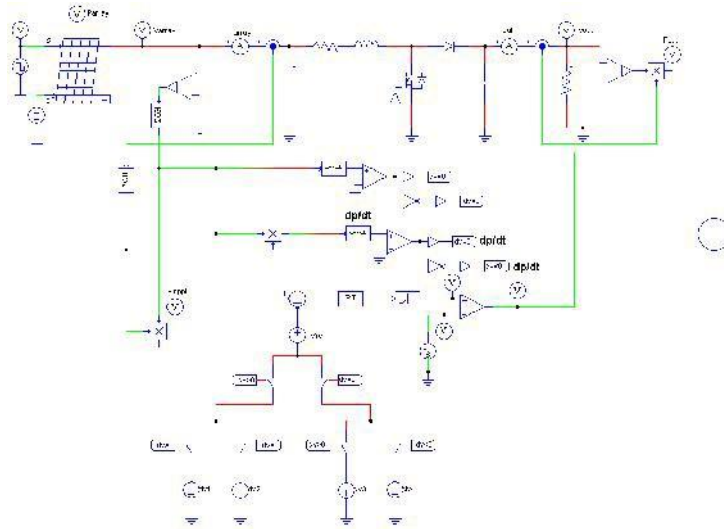

Figure 8: Simulation of PV Module with MPPT using P&O Algorithm

Table 1: Boost Converter Data

Inductor (L)	15mH
Capacitor (C)	10µF
Duty cycle	0.6144
Resistive load (RL)	20Ω

Table 2: Parameter of Solar Module Data

Number of cell in series (Ns)	144
Standard light intensity (So)	1000 w/m ²
Ref. Temperature (Tref)	25 oC
Series resistance (Rs)	0.008 ohm
Shunt resistance (Rsh)	1000 ohm
Saturation current (Iso)	2.16*e ⁸ A
Short circuit current (Isc)	3.8 A
Band energy (Eg)	1.12 eV
Ideality factor (A)	1.2 A/K
Temperature coefficient (Ct)	0.0024
Coefficient (Ks)	0
Boltzmann constant (K)	1.3806505 x 10 ⁻²³

VI. RESULTS OF P & OALGORITHM

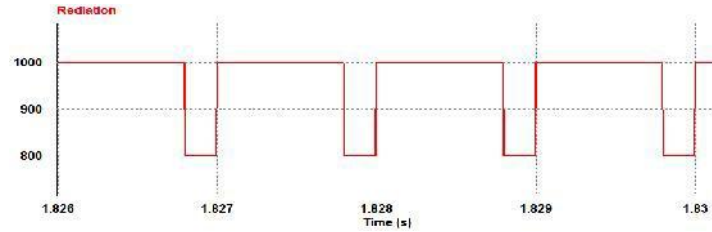

Figure 9: (a) Radiation from 1000 W/m² to 800 W/m²

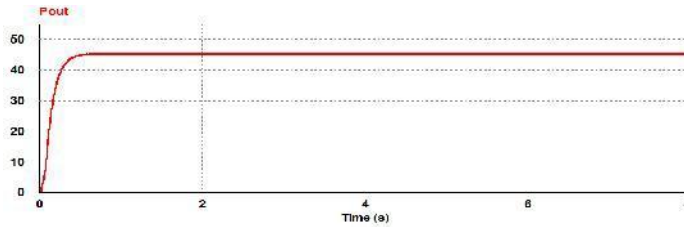

Figure 9: (b) Power Output of Boost Converter (P_{out} = 44.46 w)

Radiation and temperature are the input of PV module. In the simulation, radiation is changes from 1000W/m² to 800W/m² and the temperature is at 25° C.

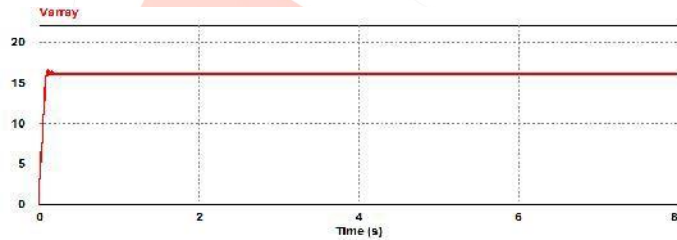

Figure 9: (c) Voltage Output of pv Module (Varray = 16.02 v)

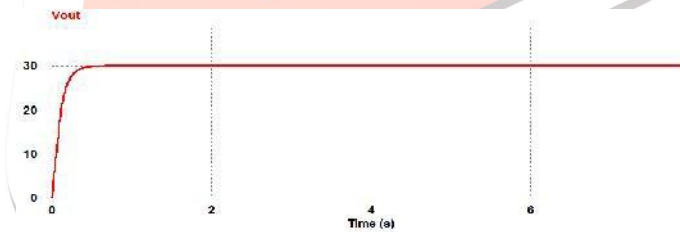

Figure 9: (d) Voltage Output of Boost Converter (Vout = 29.69v)

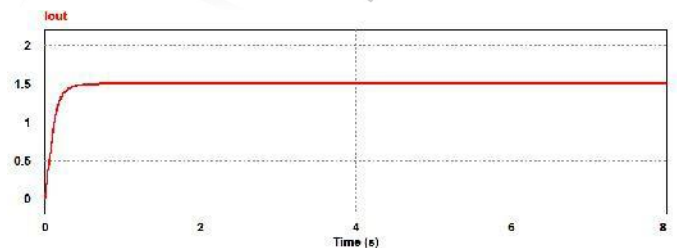

Figure 9: (e) Current Output of the Boost Converter (I_{out} = 1.4846A)

Figure 9 (c), (d) shows the output of the boost converter (V_{boost}) and output of a PV module (V_{cell}). The boost converter boosts the output voltage is an increase. The actual power can be increased.

[A]. MPPT Using Incremental Conductance Algorithm

The incremental conductance algorithm is derived by differentiating the PV array power with respect to voltage and setting the result equal to zero [3].

$$\frac{dP}{dv} = \frac{d(vI)}{dv} = v \frac{dI}{dv} + I \tag{1}$$

$$\frac{dI}{dv} = -\frac{I}{v} \tag{2}$$

In the left-hand side of equation (2) represents the opposite of the PV array's instantaneous conductance, where in the right-hand side represents its incremental conductance. When the operating point is to reach to the MPP these two quantities must be equal in magnitude and opposite in sign. If the operating point is not at the MPP it gives the relationships as shown in Equations (a, b and c) [3].

$$\frac{dI}{dv} > -\frac{I}{v} ; \left(\frac{dP}{dv} > 0 \right) \tag{a}$$

$$\frac{dI}{dv} = -\frac{I}{v} ; \left(\frac{dP}{dv} = 0 \right) \tag{b}$$

$$\frac{dI}{dv} < -\frac{I}{v} ; \left(\frac{dP}{dv} < 0 \right) \tag{c}$$

When the MPPT continues to operate at this point until a change in atmospheric conditions. The change in irradiance on the array.

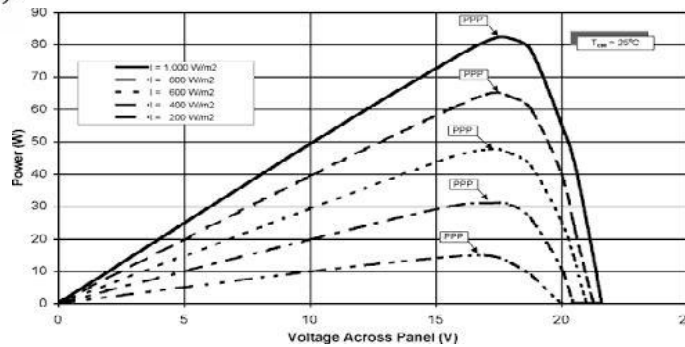

Figure 10: Photovoltaic Array Power-voltage Relationship [3]

As shown in Figure 10 the irradiance on the array increases the MPP is moves to the right side with respect to the voltage. To compensate the movement of the MPP. The MPPT must increase the array's operating voltage.

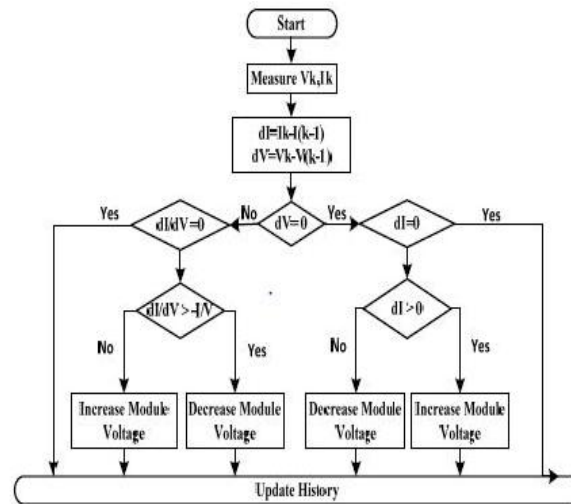

Figure 11: The Flowchart of the Inc. Algorithm [3]

Shows a flowchart for the Inc. algorithm. The present value and the previous value of the solar array voltage and current are used to calculate the values of dI and dV . If $dV=0$ and $dI=0$, then the MPPT is operating at the MPP and achieve a maximum output power of the PV array if this condition is not satisfied than check the condition the $t>0$, then the amount of sunlight has increased so raising the MPP voltage. This requires the MPPT to increase the PV array operating voltage to track the MPP. if $dI<0$ the amount of sunlight has decreased so lowering the MPP voltage and requiring the MPPT to decrease the PV array operating voltage to track the MPP.

The Same condition is check for the $dI/dV > -1/V$ then $dP/dV > 0$ and the PV array operating point is at the left of the MPP on the P-V curve, so the PV array voltage must be increased to reach the MPP. Similarly for the $dI/dV < -1/V$ then $dP/dV < 0$ and the PV array operating point is at the right of the MPP on the P-V curve so the voltage must be decreased to reach the MPP.

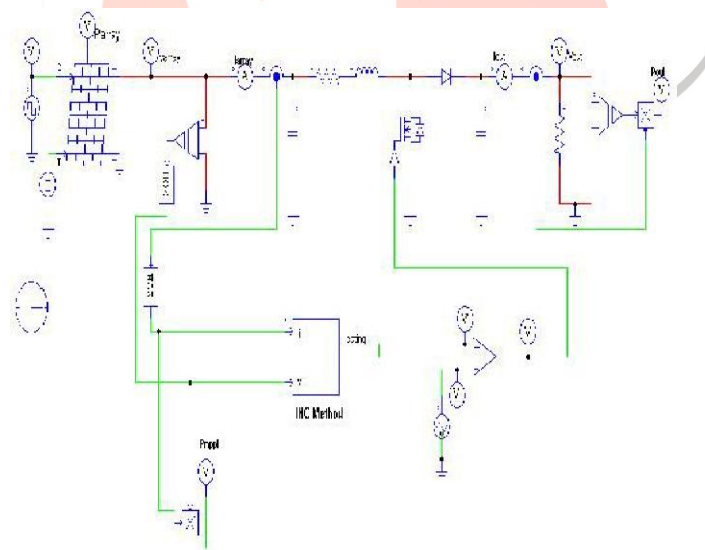

Figure 12: Simulation of PV Module with MPPT Using Inc. Algorithm

VII. RESULTS OF INC. ALGORITHM

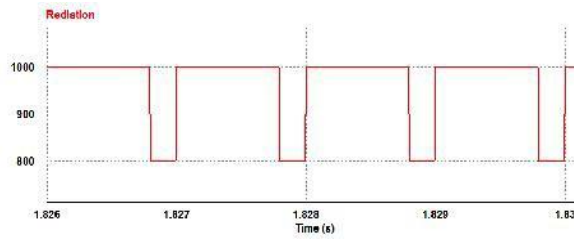

Figure 13: (a) Radiation from 1000 W/m² to 800 W/m²

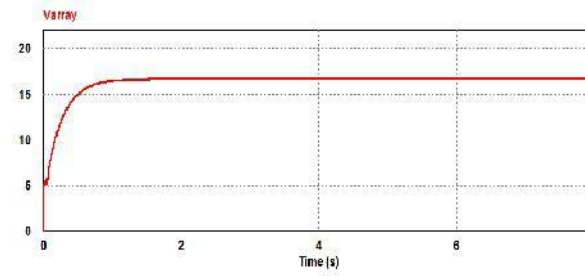

Figure 13: (b) Voltage Output of pv Module ($V_{array} = 16.28$ v)

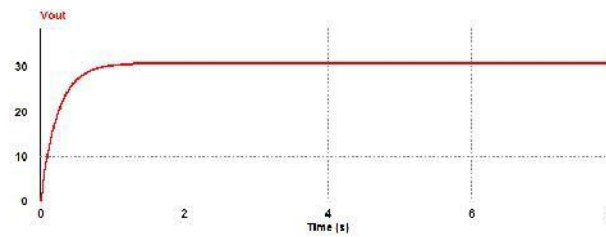

Figure 13: (c) Voltage Output of Boost Converter ($V_{out} = 29.90$ v)

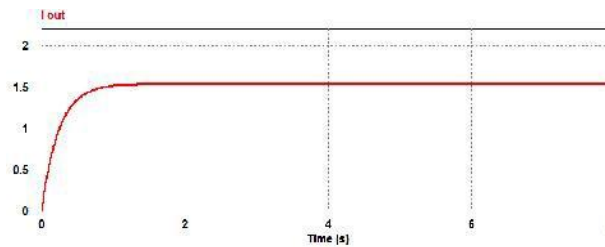

Figure 13: (d) Current Output of the Boost Converter ($I_{out} = 1.49$ A)

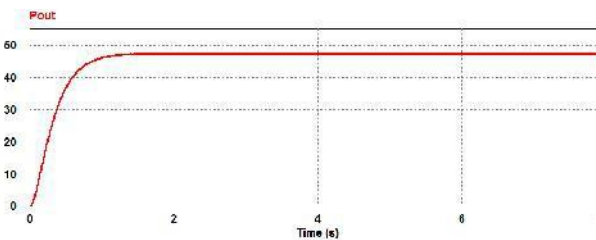

Figure 13: (e) Power Output of Boost Converter ($P_{out} = 45.43$ w)

VIII. RESULTS ANALYSTS

Table 3: Comparison of MPPT & without MPPT Techniques

	without MPPT System	P & O	INC
V array	13.18 v	16.02 v	16.28 v
V out	24.84 v	29.69 v	29.90 v
I out	1.24 A	1.4846 A	1.4954 A
P out	32.72w	44.46w	45.43w

IX. CONCLUSIONS

The results are given on the basis of maximum power point tracking. The simulation is done for a PV system to obtain maximum power with varying radiation. The result shows that the maximum power is tracked by actual power (P) using P&O and INC algorithm. The simulation result showed that the Inc-cond method has a better performance compared to the P&O method.

REFERENCES

- [1] Nicola Femia, Member, IEEE, Giovanni Petrone, Giovanni Spagnuolo, Member, IEEE, and Massimo Vitelli 'Optimization of Perturb and Observe Maximum Power Point Tracking Method' IEEE TRANSACTIONS ON POWER ELECTRONIC, VOL. 20, NO. 4, JULY 2005.
- [2] Trishan ESRAM, Student Member, and Patrick L. Chapman, Senior Member, "Comparison of Photovoltaic Array Maximum Power Point Tracking Techniques" IEEE TRANSACTIONS ON ENERGY CONVERSION, VOL. 22, NO. 2, JUNE 2007.
- [3] Prof. Kaumil B. Shah, Prof. Gajendra R. Patel, PaghdalKinjal. "Comparative Analysis of P&O and INC MPPT Algorithm for PV System." International Conference on Electrical, Electronics, Signals, Communication and Optimization (EESCO) 978-1-4799-7678-2/15/\$31.00 ©2015 IEEE.
- [4] Mr. Bhalchandra V. Chikate, Prof. D. R. Dandekar, Prof. Mrs. Y. A. Sadawarte Comparison Of Perturb & Observe and Incremental Conductance Algorithms for MPPT Controller International Journal of Advance Foundation and Research in Computer (IJAFRC) Volume 2, Issue 9, September - 2015. ISSN 2348 – 4853.
- [5] Geet Jain, Arun Shankar V.K., Umashankar "Modelling and Simulation of Solar Photovoltaic fed Induction Motor for Water Pumping Application using Perturb and Observer MPPT Algorithm" IEEE TRANJECTION Power electro. 978-1-4673-9925-8/16/\$31.00 ©2016 2016.
- [6] S. Jain and V. Agarwal, "Comparison of the performance of maximum power point tracking schemes applied to single-stage grid-connected photovoltaic systems," IET Electr. Power Appl., 2007, I, (5), pp. 753-762.
- [7] T. Chaitanya, Ch. Saibabu, I. Surya Kumari, "Modeling and Simulation of PV Array and its Performance Enhancement Using MPPT (P&O) Technique" Vol I (I), September-October 2011 pp: 9-16
- [8] Yuan Lu, Xingxing Cui, College of Electronic and Information Engineering Hebei University Baoding, China,
- [9] "Study On Maximum Power Point Tracking For Photovoltaic Power Generation System" 2010 IEEE.
- [10] SAIDIKhadidja, MAAMOUN Mountassar "Comparative study of Incremental Conductance and Perturb & Observe MPPT Methods for Photovoltaic System" 978-1-5090-6287-4/17/\$31.00 ©2017 IEEE
- [11] D. P. Hohm and M. E. Ropp "Comparative Study of Maximum Power Point Tracking Algorithms" PROGRESS IN PHOTOVOLTAICS: RESEARCH AND APPLICATIONS Res. Appl. 2003. 11:47–62 (DOI: 10.1002/pip.459).
- [12] Elgendy, M.A., Zahawi B., Atkinson, D.J. "Assessment of perturb and observe MPPT algorithm implementation techniques for PV pumping Application", IEEE TRANSACTIONS ON SUSTAINABLE ENERGY, VOL. 3 Jan 2012.
- [13] VENKATESWARLU, G., CH JHANSI, and PS RAJU. "FUZZY LOGIC BASED MAXIMUM POWER POINT TRACKING TECHNIQUE FOR PARTIALLY SHADED PHOTOVOLTAIC SYSTEM."
- [14] Femia N, Petrone G, spagnuolo G, Vitelli M 'optimizing of perturb and observe maximum power point tracking', IEEE TRANSACTIONS ON POWER ELEC. 2005; 20(4): 963-73
- [15] M. Veerachary, T. Senju, and K. Uezato, "Voltage-based maximum power point tracking control of PV system," IEEE Trans. Aerosp. Electron. Syst., vol. 38, no. 1, pp. 262–270, Jan. 2002.
- [16] Fangrui Liu, Shanxu Duan, Fei Liu, Bangyin Liu, and Yong Kang "A Variable Step Size INC MPPT Method for PV Systems" IEEE TRANSACTIONS ON INDUSTRIAL ELECTRONICS, VOL. 55, NO. 7, JULY 2008.
- [17] Mohammad A. S. Masoum, Hooman Dehbonei, and Ewald F. Fuchs, Fellow, IEEE "Theoretical and Experimental Analyses of Photovoltaic Systems with Voltage- and Current-Based Maximum Power-Point Tracking" IEEE TRANSACTIONS ON ENERGY CONVERSION, VOL. 17, NO. 4, DECEMBER 2002.
- [18] T. ESRAM and P. L. Chapman, "Comparison of photovoltaic array maximum power point tracking techniques,"
- [19] IEEE Trans. Energy Convers., vol. 22, no. 2, pp. 439–449, Jun. 2007.